

proSense™ RTD Spring-Loaded Probes with Hex Nipple

BY AUTOMATIONDIRECT



Overview

- All temperature sensors are pre-built stock items
- Spring-loaded for positive tip contact in thermowells
- 100 ohm platinum RTD 3-wire element
- Class A accuracy
- 1/4" diameter, 316 stainless steel sheath to protect against harsh environments
- RTD element encased in alumina powder insulation provides excellent vibration dampening and heat transfer
- 4", 6", or 12" probe length
- 1/2" x 1/2" NPT hex nipple allows easy replacement of existing probes and connection to a wiring junction box
- Made in the USA



RTD Spring-Loaded Probes with Hex Nipple								
Part Number	Pcs/Pkg	Wt (lb)	Price	Type	Probe Diameter (O.D.)	Probe Length	Temperature Sensing Range	Mounting
RTD1-H04L01-02	1	0.5	<--->	PT 100, 3-wire	1/4"	4"	-50 to 300°C (-58 to 572°F)	Integral 1/2" x 1/2" NPT Hex Nipple, 316 SS
RTD1-H06L01-02			<--->			6"		
RTD1-H12L01-02			<--->			12"		

Technical Specifications	
Sensing Element	Single 100 ohm platinum (Pt 100), 3-wire; TCR = 0.00385 ohm/ohm/°C
Initial Accuracy	Class A ±[0.15 +0.002 t] °C
Probe	ø1/4", 316 stainless steel sheath, single RTD is embedded in alumina powder
Response Time	7 seconds, 63% of a 25 to 77°C step change (ASTM E1137)
Wiring	3-inch Kapton insulated wire leads with terminal pins

Note: See end of section for thermowells to fit these unit..



NOTE: CHECK THE CHEMICAL COMPATIBILITY OF THE SENSOR'S WETTED PARTS WITH THE MEDIUM TO BE MEASURED.
www.automationdirect.com/static/specs/prosensechemresistance.pdf

Dimensions

RTD1-HXXL01-02

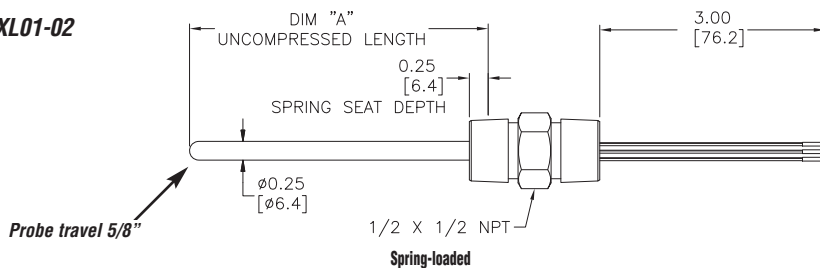

Wiring Information

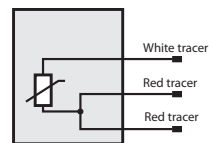

PART NUMBER	DIM "A"
RTD1-H04L01-02	4.00[101.6]
RTD1-H06L01-02	6.00[152.4]
RTD1-H12L01-02	12.00[304.8]

Dimensions shown inches [mm]

Accessories

Thermowells and RTD extension lead wire available at the end of this section.

Thermowells for Spring-Loaded Thermocouples and RTD's

TW06-01



TW06-02



Overview

- All thermowells are pre-built stock items
- Thermowells designed for use with ProSense spring-loaded thermocouple and RTD probes eliminate the need for a separate probe mounting fitting or adapter
- Drilled bar stock one piece construction (no welds) from 304 or 316 stainless steel
- 1/2" and 3/4" NPT male process threads available
- Designs and fabrication comply with ASME B31.1 and boiler and pressure vessel codes
- Material complies with NACE MR 0175 / ISO 15156
- CRN registered for all Canadian provinces
- Made in the USA



Thermowells for Spring-Loaded Thermocouples and RTD's											
Part Number	Pcs/Pkg	Wt(lb)	Price	I.D.	Overall Length/"U" Length	Male Process Threads	Female Probe Threads	Wetted Material	Temperature/Pressure Rating	Use With Probe	
TW04-01	1	0.5	<--->	0.26"	4-1/4" / 2-1/2"	1/2" NPT	1/2" NPT	304 SS	304SS: 1000°F max; 3400 psi max 316SS: 1000°F max; 5200 psi max	THMJ-C04-03 THMK-C04-03 THMJ-H04L01-02 THMK-H04L01-02 RTD1-C04-03 RTD1-H04L01-02	
TW04-02	1	0.5	<--->			3/4" NPT		304 SS			
TW04-03	1	0.5	<--->			1/2" NPT		316 SS			
TW04-04	1	0.5	<--->			3/4" NPT		316 SS			
TW06-01	1	0.7	<--->		6-1/4" / 4-1/2"	1/2" NPT		304 SS		THMJ-C06-03 THMK-C06-03 THMJ-H06L01-02 THMK-H06L01-02 RTD1-C06-03 RTD1-H06L01-02	
TW06-02	1	0.7	<--->			3/4" NPT		304 SS			
TW06-03	1	0.7	<--->			1/2" NPT		316 SS			
TW06-04	1	0.7	<--->			3/4" NPT		316 SS			
TW12-01	1	1.2	<--->		12-1/4" / 10-1/2"	1/2" NPT		304 SS			THMJ-C12-03 THMK-C12-03 THMJ-H12L01-02 THMK-H12L01-02 RTD1-C12-03 RTD1-H12L01-02
TW12-02	1	1.2	<--->			3/4" NPT		304 SS			
TW12-03	1	1.2	<--->			1/2" NPT		316 SS			
TW12-04	1	1.2	<--->			3/4" NPT		316 SS			

NOTE: CHECK THE CHEMICAL COMPATIBILITY OF THE SENSOR'S WETTED PARTS WITH THE MEDIUM TO BE MEASURED.
www.automationdirect.com/static/specs/prosensechemresistance.pdf

NOTE: RESPONSE TIME IS REDUCED WHEN INSTALLED IN A THERMOWELL. BE SURE TO INSTALL THE PROBE SO THAT IT CONTACTS THE END OF THE THERMOWELL FOR FASTER RESPONSE.. THERMAL COMPOUND MAY BE USED DEPENDING ON APPLICATION

Thermocouple or RTD and Thermowell Assembly Example



-Using spring-loaded probe design ensures positive tip contact with the bottom of the thermowell.

-Probes with hex nipple thread directly into thermowell. No additional probe mounting fittings are required.

pr^osense™ Thermowells for Spring-Loaded Thermocouples and RTD's

by AUTOMATIONDIRECT

Dimensions

TW04-XX

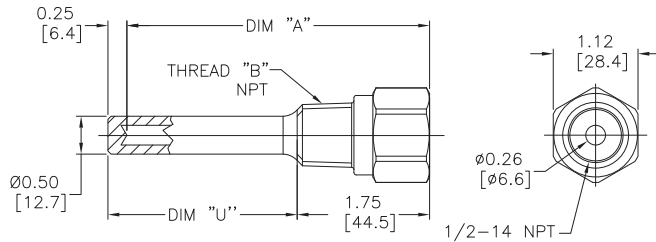

PART NUMBER	DIM "A"	THREAD "B"	DIM "U"
TW04-01	4.00 [101.6]	1/2-14	2.5 [63.5]
TW04-02	4.00 [101.6]	3/4-14	
TW04-03	4.00 [101.6]	1/2-14	
TW04-04	4.00 [101.6]	3/4-14	

TW06-XX TW12-XX

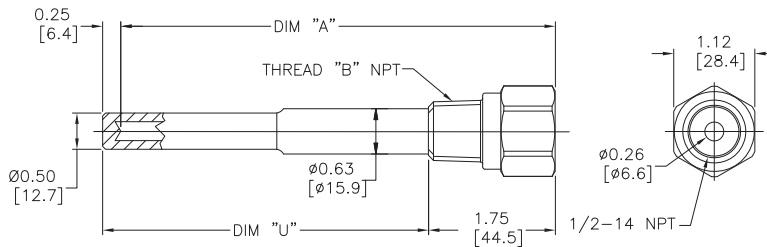

PART NUMBER	DIM "A"	THREAD "B"	DIM "U"
TW06-01	6.00 [152.4]	1/2-14	4.5 [114.3]
TW06-02	6.00 [152.4]	3/4-14	
TW06-03	6.00 [152.4]	1/2-14	
TW06-04	6.00 [152.4]	3/4-14	
TW12-01	12.00 [304.8]	1/2-14	10.5 [266.7]
TW12-02	12.00 [304.8]	3/4-14	
TW12-03	12.00 [304.8]	1/2-14	
TW12-04	12.00 [304.8]	3/4-14	

proSense™ RTD Extension Wire

by AUTOMATIONDIRECT



Company Information

Systems Overview

Programmable Controllers

Field I/O

Software

C-more & other HMI

Drives

Soft Starters

Motors & Gearbox

Steppers/ Servos

Motor Controls

Proximity Sensors

Photo Sensors

Limit Switches

Encoders

Current Sensors

Pressure Sensors

Temperature Sensors

Pushbuttons/ Lights

Process

Relays/ Timers

Comm.

Terminal Blocks & Wiring

Power

Circuit Protection

Enclosures

Tools

Pneumatics

Appendix

Product Index

Part # Index

RTDW-XX-01

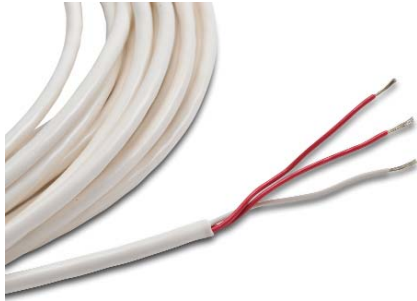

RTDW-XX-02



Overview

- Specialized construction for use as RTD extension wire offers superior performance compared to “off-the-shelf” cable
- Available insulation types include PVC and FEP Teflon with aluminum Mylar shield and copper drain wire
- Convenient 50 and 100 foot lengths



RTD Extension Wire												
Part Number	Wt (lb)	Price	Type	Length (ft)/Pkg	Gauge, AWG	Conductors	Insulation Type / Color			Ohms/Triple Foot@68°F (20°C)	Continuous Temperature Rating	Nominal Size (inches)
							Each Conductor	Inner Jacket	Outer Jacket			
RTDW-50-01	0.9	<--->	RTD	50	22	3, stranded tinned copper	PVC, 2 red, 1 white	None	PVC, white	0.044	-20°F to 221°F (-29°C to 105°C)	0.160 O.D.
RTDW-100-01	1.5	<--->		100								
RTDW-50-02	0.9	<--->		50	24	3, twisted, stranded tinned copper	FEP Teflon, 2 red, 1 white	Aluminum Mylar shield and copper drain wire	FEP Teflon, white	0.066	-328°F to 400°F (-200°C to 204°C)	0.150 O.D.
RTDW-100-02	1.5	<--->		100								



NOTE: MAXIMUM RECOMMENDED DISTANCE BETWEEN RTD AND CONTROL DEVICE IS 300 FEET.

Compression Mounting Fittings for Temperature Probes

Compression Mounting Fittings for Temperature Probes				
Part Number	Description	Pcs/Pkg	Wt(lb)	Price
BCF18-125N	Compression fitting, brass, for 1/8 inch diameter temperature probes, 1/8 inch NPT male thread	1	0.5	<--->
BCF14-125N	Compression fitting, brass, for 1/4 inch diameter temperature probes, 1/8 inch NPT male thread	1	0.5	<--->
BCF18-25N	Compression fitting, brass, for 1/8 inch diameter temperature probes, 1/4 inch NPT male thread	1	0.5	<--->
BCF14-25N	Compression fitting, brass, for 1/4 inch diameter temperature probes, 1/4 inch NPT male thread	1	0.5	<--->
BCF18-50N	Compression fitting, brass, for 1/8 inch diameter temperature probes, 1/2 inch NPT male thread	1	0.5	<--->
BCF14-50N	Compression fitting, brass, for 1/4 inch diameter temperature probes, 1/2 inch NPT male thread	1	0.5	<--->
CF18-125N	Compression fitting, 316 stainless steel, for 1/8 inch diameter temperature probes, 1/8 inch NPT male thread	1	0.5	<--->
CF14-125N	Compression fitting, 316 stainless steel, for 1/4 inch diameter temperature probes, 1/8 inch NPT male thread	1	0.5	<--->
CF18-25N	Compression fitting, 316 stainless steel, for 1/8 inch diameter temperature probes, 1/4 inch NPT male thread	1	0.5	<--->
CF14-25N	Compression fitting, 316 stainless steel, for 1/4 inch diameter temperature probes, 1/4 inch NPT male thread	1	0.5	<--->
CF18-50N	Compression fitting, 316 stainless steel, for 1/8 inch diameter temperature probes, 1/2 inch NPT male thread	1	0.5	<--->
CF14-50N	Compression fitting, 316 stainless steel, for 1/4 inch diameter temperature probes, 1/2 inch NPT male thread	1	0.5	<--->
CFTF-18	Teflon™ ferrule for brass or stainless steel compression fittings and 1/8 diameter temperature probes	5	0.5	<--->
CFTF-14	Teflon ferrule for brass or stainless steel compression fittings and 1/4 diameter temperature probes	5	0.5	<--->
CF06-25N	1/4 NPT stainless steel compression fitting for 0.24 inch (6 mm) diameter RTD probe with M12 connector.	1	0.18	<--->
CF10-50N	1/2 NPT stainless steel compression fitting for 10 mm (0.4 inch) diameter RTD probe with M12 connector.	1	0.20	<--->
CF18-BC	Bayonet compression fitting, for 1/8" diameter probe sheath sensors	1	0.1	<--->
BB125N-50N	Reducing bushing, brass, 1/2 MNPT x 1/8 FNPT, hex head	1	0.1	<--->

BCF18-125N



BCF18-25N



BCF18-50N



CF14-125N



CF14-25N



CF14-50N



NOTE: CHECK THE CHEMICAL COMPATIBILITY OF THE SENSOR'S WETTED PARTS WITH THE MEDIUM TO BE MEASURED. www.automationdirect.com/static/specs/prosensechemresistance.pdf

CFTF-18



CFTF-14



CF18-BC



BB125N-50N



CF06-25N



CF10-50N



Compression Mounting Fittings for Temperature Probes

BCF18-125N



CF14-125N



BCF18-25N



CF14-25N



BCF18-50N



CF14-25N



Dimensions

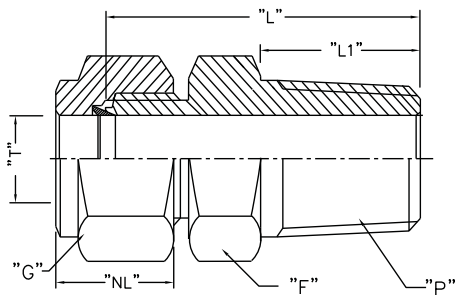

Note: All threaded connections should be hand tightened and then turned 1 to 2 full turns for proper sealing.

Actual torque required for a proper seal of NPT threads is influenced by tolerance, sealant, lubricant, etc.

ProSense Compression Fittings										
Part No.	Price	Weight (lb)	Description	"T" Tube O.D.	"P" NPT(M)	"L" Body Length*	"L1" Thread Length**	"F" Body Hex**	"G" Nut Hex**	"NL" Nut Length**
BCF18-125N/ CF18-125N	<-->	0.5	1/8" OD x 1/8" NPT(M)	0.128/0.132	1/8" NPT(M)	0.909"	0.393"	0.5"	0.433"	0.492"
BCF14-125N/ CF14-125N	<-->	0.5	1/4" OD x 1/8" NPT(M)	0.253/0.257	1/8" NPT(M)	1.0"	0.393"	0.5"	0.559"	0.5"
BCF18-25N/ CF18/25N	<-->	0.5	1/8" OD x 1/4" NPT(M)	0.128/0.132	1/4" NPT(M)	1.114"	0.551"	0.551"	0.433"	0.492"
BCF14-25N/ CF14-25N	<-->	0.5	1/4" OD x 1/4" NPT(M)	0.253/0.257	1/4" NPT(M)	1.188"	0.551"	0.551"	0.559"	0.5"
BCF18-50N/ CF18-50N	<-->	0.5	1/8" OD x 1/2" NPT(M)	0.128/0.132	1/2" NPT(M)	1.377"	0.748"	0.866"	0.433"	0.492"
BCF14-25N/ CF14-25N	<-->	0.5	1/4" OD x 1/2" NPT(M)	0.253/0.257	1/2" NPT(M)	1.437"	0.748"	0.866"	0.559"	0.5"
CF06-25N	<-->	0.18	6 mm OD x 1/4" NPT(M)	0.236/0.240	1/4" NPT(M)	1.174"	0.59"	0.67"	0.55"	0.587"
CF10-50N	<-->	0.20	10 mm OD x 1/2" NPT(M)	0.394/0.399	1/2" NPT(M)	1.458"	0.55"	1.06"	0.75"	0.608"

Note: All dimensions are in inches

* ± 0.07

** ± 0.03

Note: Once the compression fitting has been fully tightened on the probe, the ferrule will be locked onto the probe and cannot be removed or reused.

Bayonet Mounting Adapter for Temperature Sensors

Bayonet Mounting Adapter for Temperature Sensors					
Part Number	Description	Pcs/Pkg	Wt(lb)	Price	
BA-078	Bayonet adapter, 7/8 inch long, 7/16 inch outside diameter, 9/32 inch inside diameter, 1/8 inch MNPT	1	0.5	<--->	
BA-100	Bayonet adapter, 1 inch long, 7/16 inch outside diameter, 9/32 inch inside diameter, 1/8 inch MNPT	1	0.5	<--->	
BA-114	Bayonet adapter, 1-1/4 inch long, 7/16 inch outside diameter, 9/32 inch inside diameter, 1/8 inch MNPT	1	0.5	<--->	
BA-112	Bayonet adapter, 1-1/2 inch long, 7/16 inch outside diameter, 9/32 inch inside diameter, 1/8 inch MNPT	1	0.5	<--->	
BA-200	Bayonet adapter, 2 inch long, 7/16 inch outside diameter, 9/32 inch inside diameter, 1/8 inch MNPT	1	0.5	<--->	
BA-212	Bayonet adapter, 2-1/2 inch long, 7/16 inch outside diameter, 9/32 inch inside diameter, 1/8 inch MNPT	1	0.5	<--->	
BA-300	Bayonet adapter, 3 inch long, 7/16 inch outside diameter, 9/32 inch inside diameter, 1/8 inch MNPT	1	0.5	<--->	
BA-312	Bayonet adapter, 3-1/2 inch long, 7/16 inch outside diameter, 9/32 inch inside diameter, 1/8 inch MNPT	1	0.5	<--->	
CF18-BC	Adjustable bayonet compression fitting, for 1/8" diameter probe sheath sensors	1	0.1	<--->	
BB125N-50N	Reducing bushing, brass, 1/2 MNPT x 1/8 FNPT, hex head	1	0.1	<--->	



NOTE: CHECK THE CHEMICAL COMPATIBILITY OF THE SENSOR'S WETTED PARTS WITH THE MEDIUM TO BE MEASURED. www.automationdirect.com/static/specs/prosensechemresistance.pdf

BA-078



BA-100



BA-114



CF18-BC



BA-300



BA-112



BB125N-50N



BA-312



BA-200



BA-212



Thermocouple and RTD Connectors

Overview

- Glass-filled high quality thermoplastic body with original thermocouple material pins and spring-loaded inserts
- Polarized pins
- Molded barriers prevent short circuit
- Captive central cover screw for easy assembly
- Easy wire connection pressure plate construction

- Stainless steel screws with combination head (Slotted and Phillips)
- 3-Pin standard connectors have a third pin for ground or continuous shield, or for three wire RTDs



Thermocouple and RTD Connectors									
Part Number	Pcs/ Pkg	Wt(lb)	Price	Sensor Type	Connector Type	Temperature Rating	Body Color	Wire Size	Wire Cable Clamp Bracket
THMJ-SP	1	0.5	<--->	J	Standard round pin plug	Max continuous 400°F (200°C)	Black	32 AWG (0.2 mm) to 14 AWG maximum (2.0 mm)	WCB-S
THMJ-SJ	1	0.5	<--->		Standard round pin jack				
THMK-SP	1	0.5	<--->	K	Standard round pin plug		Yellow		
THMK-SJ	1	0.5	<--->		Standard round pin jack				
THMJ-MP	1	0.5	<--->	J	Miniature flat pin plug		Black	40 AWG (0.08 mm) to 20 AWG maximum (0.6 mm)	WCB-M
THMJ-MJ	1	0.5	<--->		Miniature flat pin jack				
THMK-MP	1	0.5	<--->	K	Miniature flat pin plug				
THMK-MJ	1	0.5	<--->		Miniature flat pin jack				
RTD-SP	1	0.5	<--->	RTD	Standard round pin plug		White	32 AWG (0.2 mm) to 14 AWG maximum (2.0 mm)	WCB-S
RTD-SJ	1	0.5	<--->		Standard round pin jack				



NOTE: CHECK THE CHEMICAL COMPATIBILITY OF THE SENSOR'S WETTED PARTS WITH THE MEDIUM TO BE MEASURED.
www.automationdirect.com/static/specs/prosensechemresistance.pdf

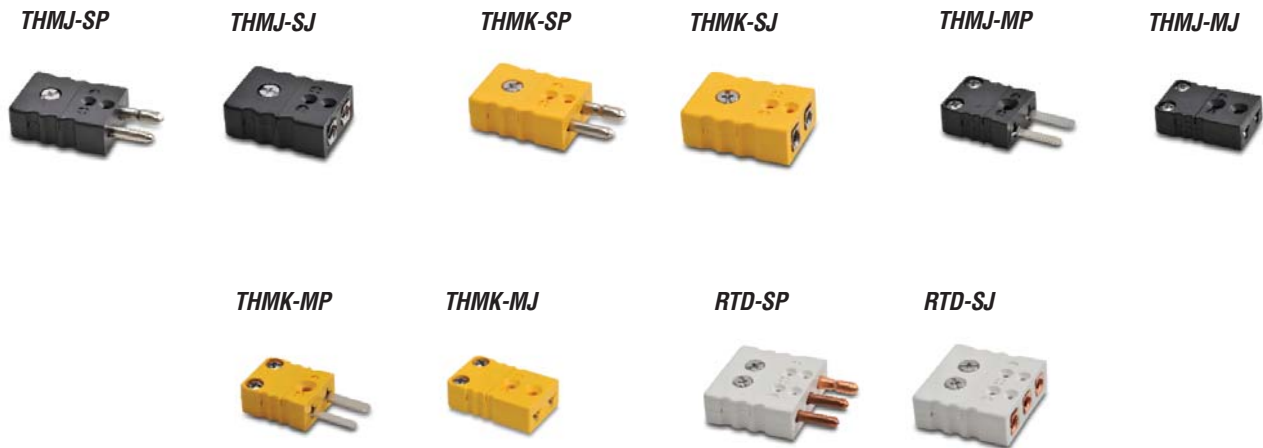

Thermocouple and RTD Connectors

Dimensions

THMJ-SP

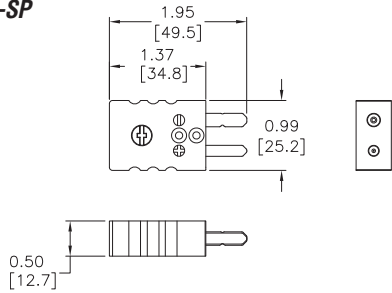

THMJ-SJ

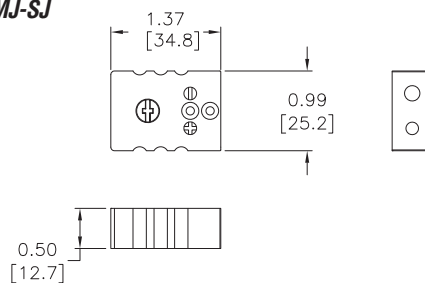

THMK-SP

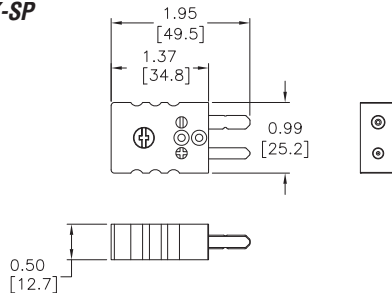

THMK-SJ

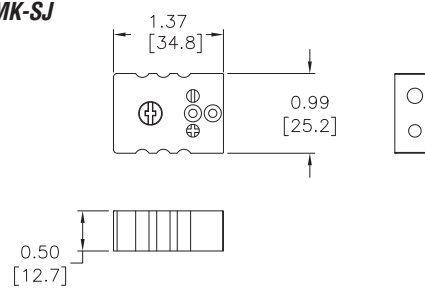

THMJ-MP

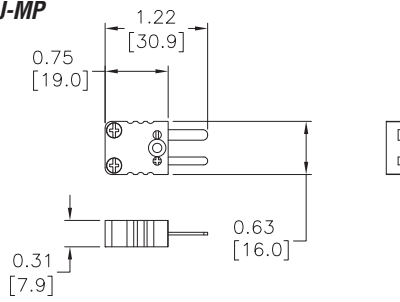

THMJ-MJ

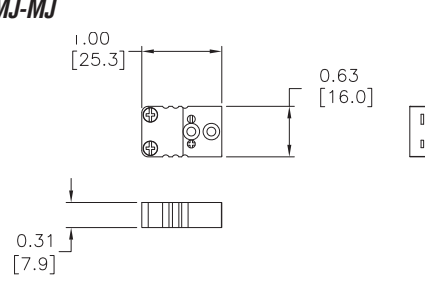

THMK-MP

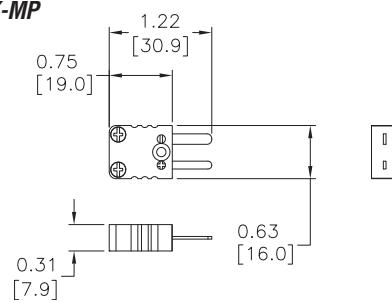

THMK-MJ

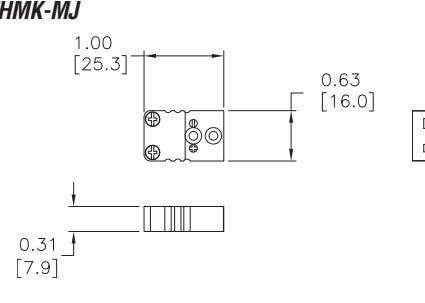

RTD-SP

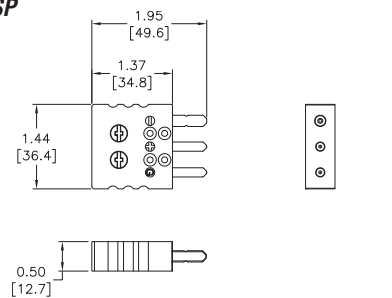

RTD-SJ

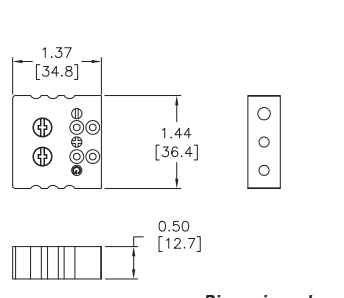

Dimensions shown inches [mm]

Thermocouple and RTD Connectors

WCB-S



WCB-M



WCB-S Application



WCB-M Application



Thermocouple and RTD Connectors Accessories				
Part Number	Pcs/ Pkg	Wt(lb)	Price	Description
WCB-S	4	0.5	<--->	Wire / cable clamp bracket for use with standard thermocouple and RTD connectors.
WCB-M	4	0.5	<--->	Wire / cable clamp bracket for use with miniature thermocouple connectors.

Dimensions

WCB-S

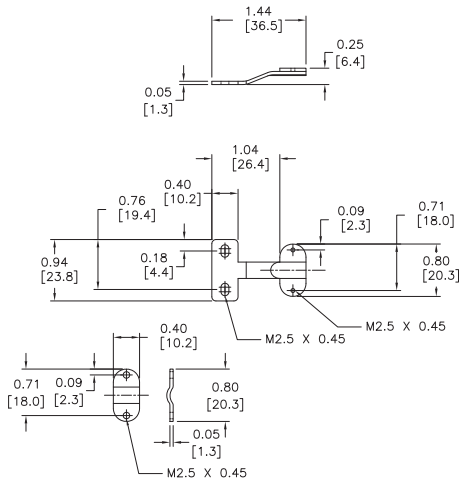

WCB-M

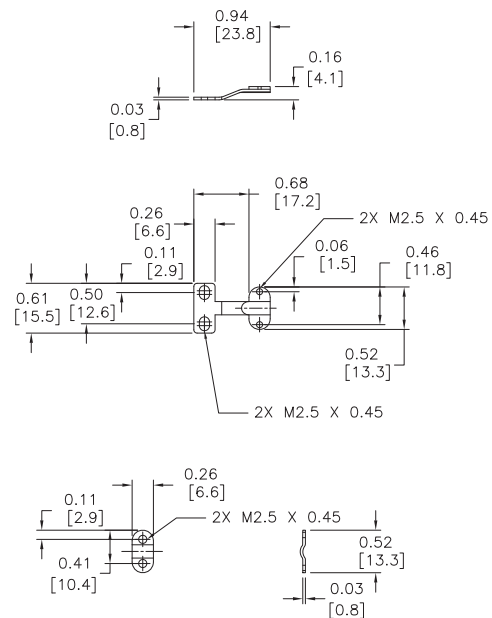

Dimensions shown inches [mm]