

CT Series Capacitive Proximity Sensors

M30 (30 mm) metal – DC



- 6 models available
- Sensitivity adjustment with 20-turns trimmer
- Metal housing with axial cable
- Detects metallic and non-metallic objects
- Complete overload protection
- IP65 rated
- Double LED status indicators

CT Series 30DC Capacitive Prox Sensor Selection Chart

Part Number	Price	Sensing Range	Housing	Output State	Logic	Connection
CT1-AN-1A	<--->	2 to 15mm (0.079-0.59in)	Shielded	N.O.	NPN	2m (6.5') axial cable
CT1-AP-1A	<--->				PNP	2m (6.5') axial cable
CT1-AN-2A	<--->	2 to 20mm (0.079-0.70in)	Unshielded	N.O.	NPN	2m (6.5') axial cable
CT1-AP-2A	<--->				PNP	2m (6.5') axial cable
CT1-CN-2A	<--->	2 to 20mm (0.079-0.70in)	Unshielded	N.C.	NPN	2m (6.5') axial cable
CT1-CP-2A	<--->				PNP	2m (6.5') axial cable

Specifications

Type	Shielded	Unshielded
Operating Distance	2-15mm (0.079-0.59in)	2-20mm (0.079-0.70in)
Differential Travel	2 to 20%	
Repeat Accuracy	10%	
Operating Voltage	10-30VDC	
Ripple	≤10%	
No-load Supply Current	8mA	
Load Current	≤200mA	
Leakage Current	≤10µA	
Voltage Drop	1.8 volts maximum	
Output Type	NPN or PNP / N.O. or N.C. / 3-wire	
Switching Frequency	100Hz	
(tv) Time Delay Before Availability	100ms	
Input Voltage Transient Protection	Yes, only if transient peak does not exceed 30VDC	
Input Power Polarity Reversal Protection	Yes	
Output Power Short-Circuit Protection	Yes (switch auto-resets after overload is removed)	
Temperature Range	-25° to +70° C (-13° to 158° F)	
Temperature Drift	20% Sr	
Protection Degree (DIN 40050)	IEC IP65	
LED Indicators	Green (supply), Red (N.O. output energized)	
Housing Material	Nickel-plated brass	
Sensing Face Material	PBT	
Tightening Torque	100Nm (73.7lb./ft.)	
Weight (cable/connector)	280g (19.88oz)	

Dimensions

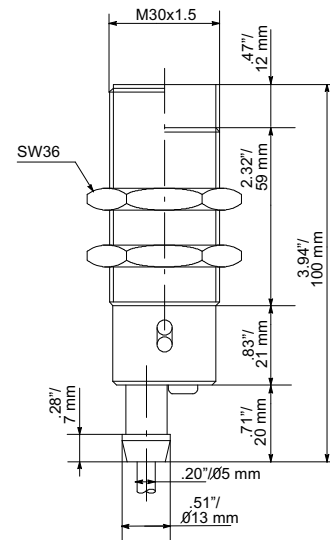

Wiring diagrams

NPN output

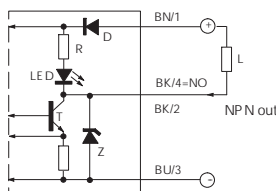

PNP output

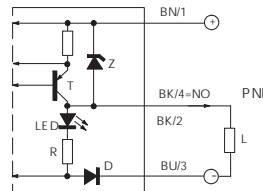

Sensors Accessories: Cables

Cables with quick-disconnect plugs

- Industry standard axial and right-angle M8/M12 screw-lock connectors with open leads. The cables listed can be used with patch cables
- 2m, 5m, 7m and 10m cable lengths

- PVC (polyvinyl chloride) jacket for typical industrial applications
- PUR (polyurethane) jacket for oily and direct sunlight applications
- IP67 rated



M8 Quick-Disconnect Cables (Pico, Nano)							
Part Number	Price	Length	Poles	Connector	LED	Jacket	Dimensions
M8 Quick-Disconnects							
CD08-0A-020-A1	<--->	2m (6.5ft.)	3	Axial	No	PVC	Figure 1
CD08-0A-020-C1	<--->	2m (6.5ft.)	3	Right-angle	No	PVC	Figure 2
CD08-0A-050-A1	<--->	5m (16.4ft.)	3	Axial	No	PVC	Figure 4
CD08-0C-050-A1	<--->	5m (16.4ft.)	3	Axial	No	PUR	Figure 3
CD08-0A-050-C1	<--->	5m (16.4ft.)	3	Right-angle	No	PVC	Figure 5
CD08-0C-050-C1	<--->	5m (16.4ft.)	3	Right-angle	No	PUR	Figure 5
CD08-0A-070-A1	<--->	7m (23ft.)	3	Axial	No	PVC	Figure 1
CD08-0A-070-C1	<--->	7m (23ft.)	3	Right-angle	No	PVC	Figure 2

M12 Quick-Disconnect Cables (Euro, Micro DC-Single Key)							
Part Number	Price	Length	Poles	Connector	LED	Jacket	Dimensions
M12 Quick-Disconnects							
CD12L-0B-020-A0	<--->	2m (6.5ft)	4	Axial	No	PVC	Figure 6
CD12L-0B-020-C0	<--->	2m (6.5ft)	4	Right-angle	No	PVC	Figure 7
CD12M-0B-050-A1*	<--->	5m (16.4ft)	3	Axial	No	PVC	Figure 8
CD12M-0D-050-A1*	<--->	5m (16.4ft)	3	Axial	No	PUR	Figure 9
CD12M-0B-050-C1*	<--->	5m (16.4ft)	3	Right-angle	No	PVC	Figure 10
CD12M-0D-050-C1*	<--->	5m (16.4ft)	3	Right-angle	No	PUR	Figure 11
CD12M-0B-070-A1	<--->	7m (23ft)	4	Axial	No	PVC	Figure 6
CD12M-0B-070-C1	<--->	7m (23ft)	4	Right-angle	No	PVC	Figure 7

* Note: Do not use with: DM, FA, QX, SS, SSF, SU, TU, VM, VK, MV, MS or MSF series sensors. These sensors require 4-pole cables.

CD12M-0B-050-C1 and -A1 shown

Cables with LED and quick-disconnect plugs

- Industry standard M12 right angle female plug with open leads
- These cables can be used with patch cables
- 2m, 5m and 10m cable lengths

- PUR (polyurethane) jacket for oily and direct sunlight applications
- IP67 /IP68 / IP69K, II rated
- LED indication for 10 -36 VDC PNP sensors only

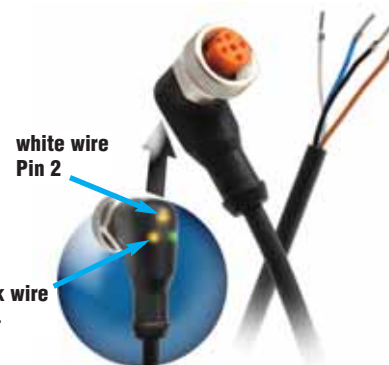

M12 Quick-Disconnect Cables with LED Indicator (Euro, Micro DC-Single Key)							
Part Number	Price	Length	Poles	Connector	LED	Jacket	Dimensions
M12 Quick-Disconnects							
EVC178*	<--->	2m (6.5ft)	4	Right-angle	Yes	PUR	Figure 12
EVC179*	<--->	5m (16.4ft)	4	Right-angle	Yes	PUR	Figure 12
EVC180*	<--->	10m (32.8ft)	4	Right-angle	Yes	PUR	Figure 12

*Note: LED for 10 to 36 VDC PNP only.
Do not use when white wire (Pin 2) is used for selection of a sensor function.

LED Models' Wiring

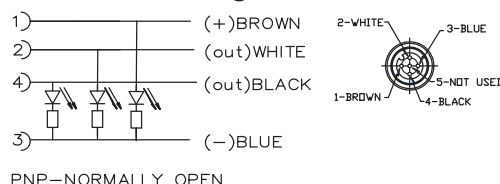

Sensors Accessories: Cables



Company Information

Systems Overview

Programmable Controllers

Field I/O

Software

C-more & other HMI

Drives

Soft Starters

Motors & Gearbox

Steppers/ Servos

Motor Controls

Proximity Sensors

Photo Sensors

Limit Switches

Encoders

Current Sensors

Pressure Sensors

Temperature Sensors

Pushbuttons/ Lights

Process

Relays/ Timers

Comm.

Terminal Blocks & Wiring

Power

Circuit Protection

Enclosures

Tools

Pneumatics

Appendix

Product Index

Part # Index

Cable Specifications

Specification	M8		M12		M12 with LED
Length	2m (6.5ft) / 7m (23ft)	5m (16.4ft)	2m (6.5ft) / 7m (23ft)	5m (16.4ft)	2m (6.5 ft) / 5m (16.4ft) / 10m (32.8ft)
Nominal Voltage	50VAC/75VDC	60VAC/DC	300VAC	250VAC/DC	10 to 36VDC
Max Current	4A		4A		4A
LED Current Loading	N/A	N/A	N/A	N/A	10V input Brown wire LED: 1.7mA White and/or Black LED: 0.9mA 36V input Brown wire LED: 7.3mA White and/or Black LED: 4.7mA
Protection Degree	IP67	IP65 / IP68 / IP69K	IP67	PVC: IP68 PUR: IP68 / IP69K	IP67 / IP68 / IP69K
Material Nut	brass; nickel plated		brass; nickel plated		brass; nickel plated
Jacket Material	PVC	PVC:CD08-0A-xxx. PUR:CD08-0C-xxx	PVC	PVC:CD12M-0B-xxx. PUR:CD12M-0D-xxx	PUR
Housing Material	PUR		PUR		PUR
Contacts Material	Copper-Tin Alloy (CuSn) -gold plated		Copper-Tin Alloy (CuSn) -gold plated		Gold plated brass
Tightening Torque	0.5 Nm	≤ 0.4 Nm	0.5 Nm	≤ 0.4 Nm	0.6 to 1.5 Nm
Conductors Cross Section (AWG)	0.25mm ² (24 AWG)	0.25mm ² (24 AWG)	0.25mm ² (24 AWG)	0.34mm ² (22 AWG)	4 x 0.34mm ² (4 x 22 AWG)
Ø Outer Cable	5mm	PVC: 4 mm PUR: 4 mm	5mm	PVC: 4.2 mm PUR: 4.3 mm	5mm
Temperature Range	-25° to +80°C (-13° to 176°F)	-25° to 90°C (-13° to 194°F)	-25° to +80°C (-13° to 176°F)	PVC: -30° to 70°C (-22° to 158°F) PUR: -50° to 90°C (-58° to 194°F)	-25° to +90°C (-13° to 194°F)
Environmental	N/A	Halogen free, Silicone free	N/A	Halogen free, Silicone free	Halogen free, Silicone free
Function Display Power LED	N/A	N/A	N/A	N/A	Green
Switching Status LED	N/A	N/A	N/A	N/A	2 x Yellow
Drag Chain (Roller Cable Tray) Suitability	Bending Radius	min. 10 x cable diameter			
	Bending Cycles	N/A	N/A	N/A	>5 million
	Travel Speed	N/A	N/A	N/A	Max. 3.3 m/s for a horizontal travel length of 5 meters and max. acceleration of 5 m/s ²
	Torsional Strain	N/A	N/A	N/A	±180°/m
Agency Approvals	RoHS				UL File E191684, RoHS

UL Reference

Part Number	Mini-Series Female Cord Connectors Series M12, UL Catalog Number
EVC178	ADOAH043MSS0002H04
EVC179	ADOAH043MSS0005H04
EVC180	ADOAH043MSS0010H04
Note: Shown in UL file under Mini-series Female Cord Connectors using catalog number	

Sensors Accessories: Cables

Dimensions (in/mm)

Figure 1

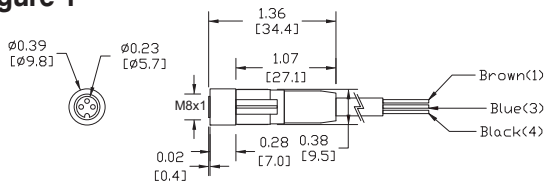

Figure 2

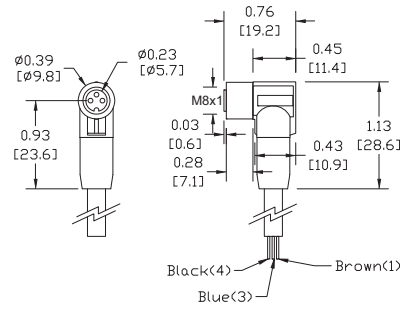

Figure 3

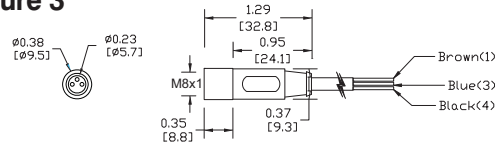

Figure 4

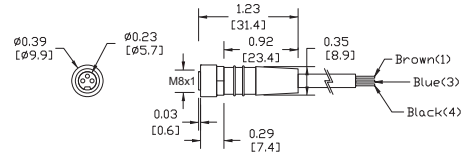

Figure 5

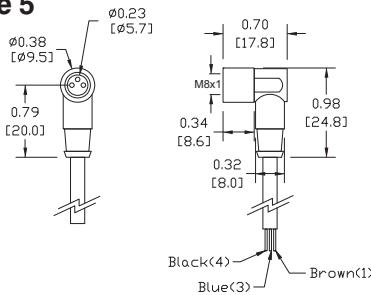

Figure 6

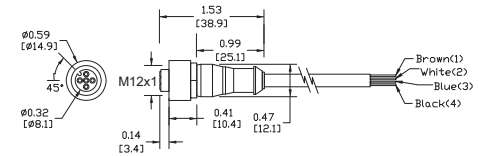

Figure 7

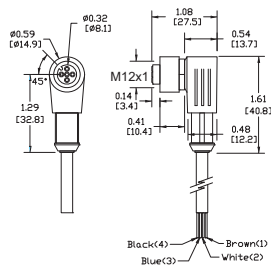

Figure 8

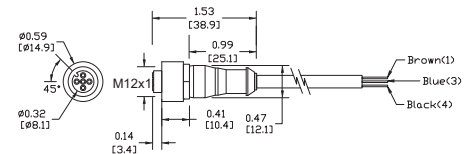

Figure 9

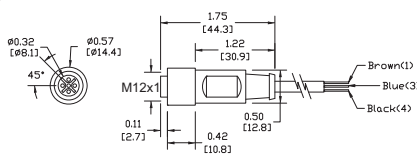

Figure 10

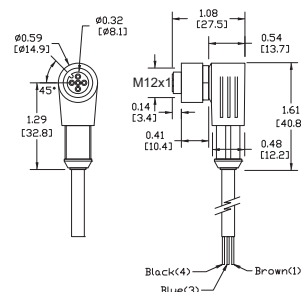

Figure 11

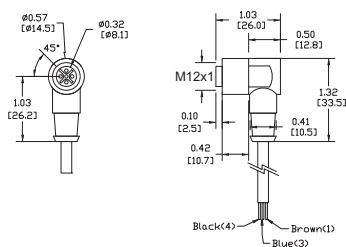
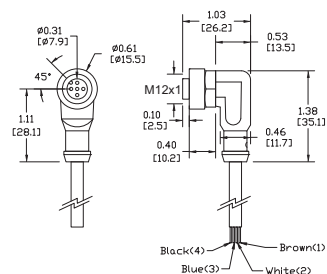

Figure 12



Sensors Accessories: Cables

Patch cables with quick-disconnect plugs on each end

Available patch cables include:

- Industry standard M8 and M12 screw-lock connectors
- One male and one female connector

- Axial and right-angle connector models
- 1m and 3m cable lengths
- PVC (polyvinyl chloride) jacket for typical industrial applications
- IP67 rated



M8 Patch Cables with Quick-Disconnect on Each End (Pico, Nano)						
Part Number	Price	Length	Poles	Connectors	Jacket	Dimensions
M8 Quick-Disconnect Patch Cables						
CDP08-0A-010-AA	<--->	1m (3.28ft)	3	2 Axial. One male and one female connector	PVC	Figure 1
CDP08-0A-010-BB	<--->	1m (3.28ft)	3	2 Right-angle. One male and one female connector	PVC	Figure 3
CDP08-0A-030-AA	<--->	3m (9.84ft)	3	2 Axial. One male and one female connector	PVC	Figure 2
CDP08-0A-030-BB	<--->	3m (9.84ft)	3	2 Right-angle. One male and one female connector	PVC	Figure 3

M12 Patch Cables with Quick-Disconnect on Each End (Euro, Micro DC-Single Key)						
Part Number	Price	Length	Poles	Connectors	Jacket	Dimensions
M12 Quick-disconnect Patch Cables						
CDP12-0B-010-AA	<--->	1m (3.28ft)	4	2 Axial. One male and one female connector	PVC	Figure 4
CDP12-0B-010-BB	<--->	1m (3.28ft)	4	2 Right-angle. One male and one female connector	PVC	Figure 5
CDP12-0B-030-AA	<--->	3m (9.84ft)	4	2 Axial. One male and one female connector	PVC	Figure 4
CDP12-0B-030-BB	<--->	3m (9.84ft)	4	2 Right-angle. One male and one female connector	PVC	Figure 5

Patch Cables with LED

Available patch cables with LED include:

- Right-angle M12 female plug with LED indication on one end and axial male plug on the other end
- 0.3m, 0.6m, 1m, 2m, 5m, and 10m cable lengths

- PUR (polyurethane) jacket for oily and direct sunlight applications
- IP67 / IP68 / IP69K, II rated
- LED indication for 10 -36 VDC PNP sensors only

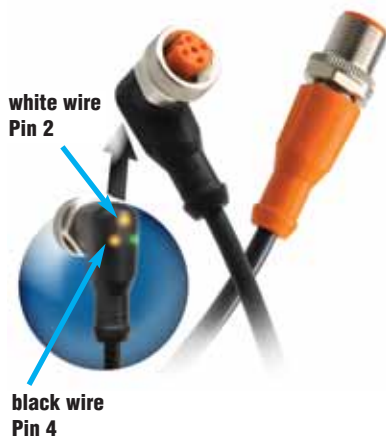

LED Models' Wiring

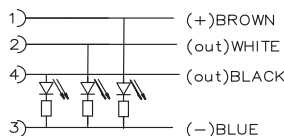

M12 Patch Cables with LED Indicator (Euro, Micro DC-Single Key)							
Part Number	Price	Length	Poles	Connectors	LED	Jacket	Dimensions
M12 Patch Cables							
EVC322*	<--->	0.3m (0.98ft)	4	Right-angle female, axial male	Yes	PUR	Figure 6
EVC323*	<--->	0.6m (1.97ft)	4	Right-angle female, axial male	Yes	PUR	Figure 6
EVC324*	<--->	1m (3.28ft)	4	Right-angle female, axial male	Yes	PUR	Figure 6
EVC325*	<--->	2m (6.5ft)	4	Right-angle female, axial male	Yes	PUR	Figure 6
EVC326*	<--->	5m (16.4ft)	4	Right-angle female, axial male	Yes	PUR	Figure 6
EVC327*	<--->	10m (32.8ft)	4	Right-angle female, axial male	Yes	PUR	Figure 6

**Note: LED for 10 to 36 VDC PNP only.
Do not use when white wire (Pin 2) is used for selection of a sensor function.**



Company Information

Systems Overview

Programmable Controllers

Field I/O

Software

C-more & other HMI

Drives

Soft Starters

Motors & Gearbox

Steppers/ Servos

Motor Controls

Proximity Sensors

Photo Sensors

Limit Switches

Encoders

Current Sensors

Pressure Sensors

Temperature Sensors

Pushbuttons/ Lights

Process

Relays/ Timers

Comm.

Terminal Blocks & Wiring

Power

Circuit Protection

Enclosures

Tools

Pneumatics

Appendix

Product Index

Part # Index

Sensors Accessories: Cables

Cable Specifications		
Specification	M8 / M12	M12 with LED
Length	1m (3.28ft.) / 3m (9.84ft.)	0.3m (0.98ft) / 0.6m (1.97ft) / 1m (3.28ft) 2m (6.5ft) / 5m (16.4ft) / 10m (32.8ft)
Nominal Voltage	50VAC/75VDC	10 to 36VDC
Max Current	4A	4A
	N/A	10V input Brown wire LED: 1.7mA White and/or Black LED: 0.9mA 36V input Brown wire LED: 7.3mA White and/or Black LED: 4.7mA
Protection Degree	IEC IP67	IEC IP67/IP68/IP69K
Material Nut	Brass: nickel plated	Brass: nickel plated
Jacket Material	PVC	PUR
Housing Material	PUR	Connector: Orange PUR, Socket: Black PUR
Contacts Material	Copper-tin(CuSn)=Brass	Brass; gold plated
Conductors Cross Section (AWG)	0.34mm ²	0.34mm ² (22 AWG)
Tightening Torque	0.5 Nm	Plug: 0.6 to 1.5 Nm (take into account the maximum value of the counterpart) Socket: 0.6 to 1.5 Nm
Ø Outer Cable	5mm	5mm
Temperature Range	-25° to +70°C (-13° to 158°F)	-25° to +90°C (-13° to 194°F)
Environmental		Halogen-free, Silicone-free
Function Display LED	N/A	Green
Switching Status LED	N/A	2 x Yellow
Drag Chain (Roller Cable Tray) Suitability	Bending Radius	min. 10 x cable diameter
	Bending Cycles	>5 million
	Travel Speed	N/A Max. 3.3 m/s for a horizontal travel length of 5 m and max. acceleration of 5 m/s ²
	Torsional Strain	N/A ±180°/m
Agency Approvals	RoHS	UL File E191684, RoHS

UL Reference	
Part Number	Cable Assemblies Series M12, UL Catalog Number
EVC322	VDOAH043MSS00.3H04STGH040MSS
EVC323	VDOAH043MSS00.6H04STGH040MSS
EVC324	VDOAH043MSS0001H04STGH040MSS
EVC325	VDOAH043MSS0002H04STGH040MSS
EVC326	VDOAH043MSS0005H04STGH040MSS
EVC327	VDOAH043MSS0010H04STGH040MSS
<i>Note: Shown in UL file under Cable Assemblies using catalog number</i>	

Sensors Accessories: Cables

Dimensions (in/mm)

Figure 1

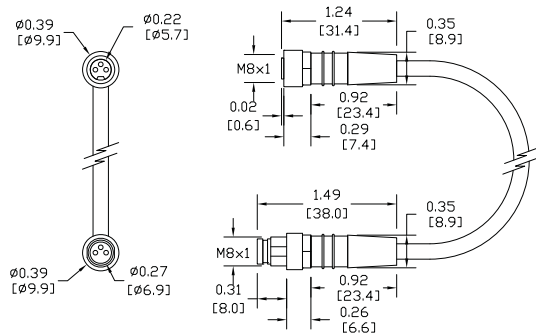

Figure 2

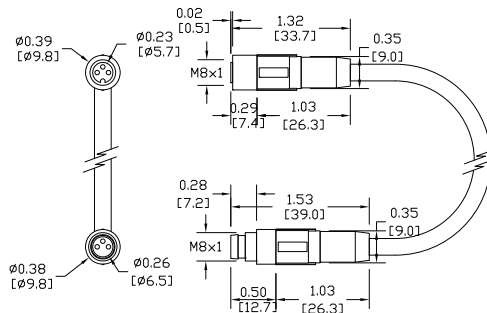

Figure 3

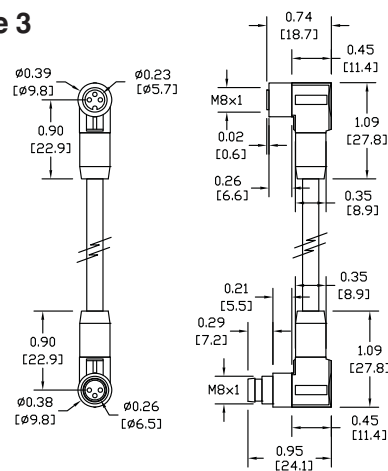

Figure 4

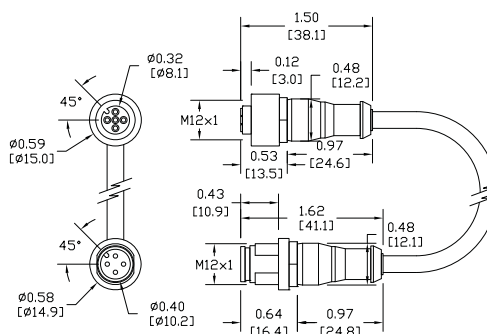

Figure 5

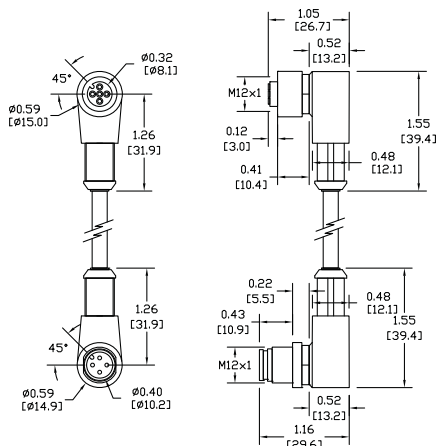
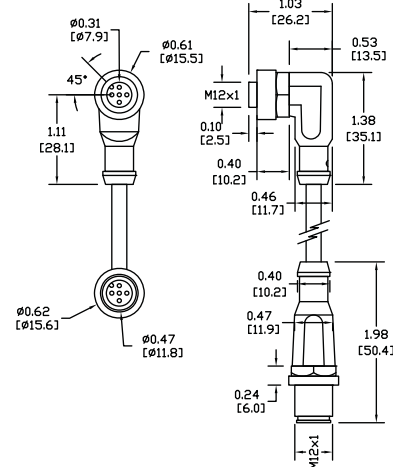

Figure 6



Company Information

Systems Overview

Programmable Controllers

Field I/O

Software

C-more & other HMI

Drives

Soft Starters

Motors & Gearbox

Steppers/ Servos

Motor Controls

Proximity Sensors

Photo Sensors

Limit Switches

Encoders

Current Sensors

Pressure Sensors

Temperature Sensors

Pushbuttons/ Lights

Process

Relays/ Timers

Comm.

Terminal Blocks & Wiring

Power

Circuit Protection

Enclosures

Tools

Pneumatics

Appendix

Product Index

Part # Index

Accessories: Adapter, Mounting Brackets

ST12A axial bracket

For mounting M12 (12 mm) sensors. Has two mounting holes (use 3 mm screws) and allows the rotation of an optical axis for right-beam angle adapter sensors. Hexagonal nuts not included.



ST12C right-angle bracket

Angular mounting bracket for use with M12 (12 mm) sensors. Has two mounting holes (use 3 mm screws) and allows the rotation of an optical axis for axial sensors. Hexagonal nuts not included.



Brackets		
Part Number	Price	Description
ST12A	<-->	Metal axial bracket for 12 mm sensors, 1/pk
ST12A7W	<-->	316L stainless steel axial bracket for 12 mm sensors, 1/pk

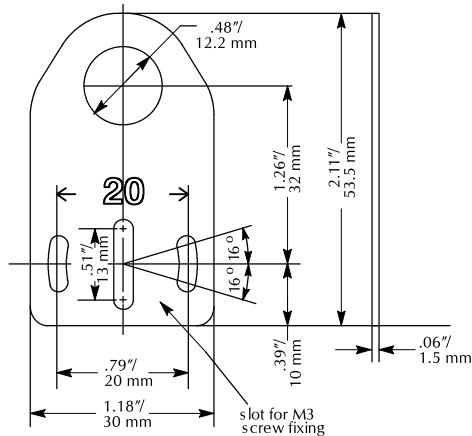

Brackets		
Part Number	Price	Description
ST12C	<-->	Metal right angle bracket for 12 mm sensors, 1/pk
ST12C7W	<-->	316L stainless steel right angle bracket for 12 mm sensors, 1/pk

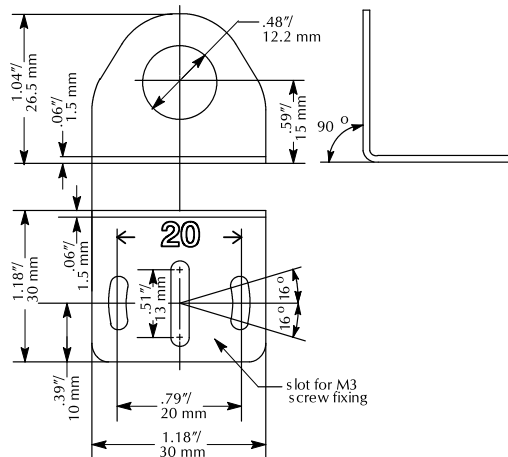

ST18A axial bracket

Mounting bracket for M18 (18 mm) sensors. Has two mounting holes (use 4 mm screws) and allows the rotation of an optical axis for right-beam-angle-adaptor sensors. Hexagonal nuts not included.



ST18C right-angle bracket

Angular mounting bracket for M18 (18 mm) sensors. Has two mounting holes (use 4 mm screws) and allows the rotation of an optical axis for axial sensors. Hexagonal nuts not included.



Brackets		
Part Number	Price	Description
ST18A	<-->	Metal axial bracket for 18 mm sensors, 1/pk
ST18A7W	<-->	316L stainless steel axial bracket for 18 mm sensors, 1/pk

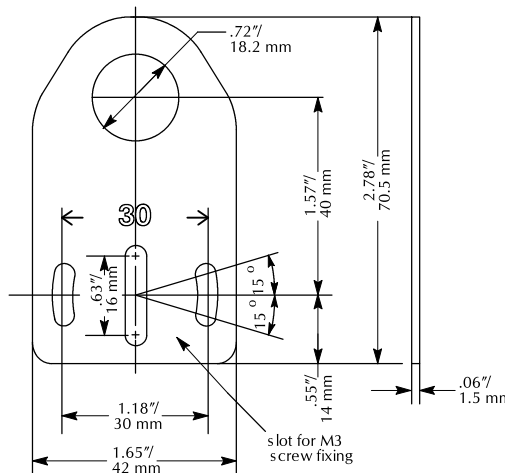

Brackets		
Part Number	Price	Description
ST18C	<-->	Metal right angle bracket for 18 mm sensors, 1/pk
ST18C7W	<-->	316L stainless steel right angle bracket for 18 mm sensors, 1/pk

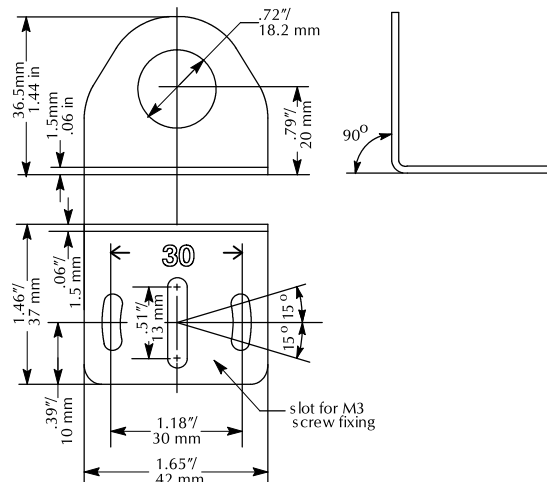

Accessories: Mounting Brackets

ST30A axial bracket

Mounting M30 (30 mm) sensors. Has two mounting holes (use 5 mm screws) and allows the rotation of an optical axis for right-beam-angle-adapter sensors. Hexagonal nuts not included.



ST30C right-angle bracket

Angular mounting bracket for M30 (30 mm) sensors. Has two mounting holes (use 5 mm screws) and allows the rotation of an optical axis for axial sensors. Hexagonal nuts not included.



Brackets		
Part Number	Price	Description
ST30A	<--->	Metal axial bracket for 30 mm sensors, 1/pk

Brackets		
Part Number	Price	Description
ST30C	<--->	Metal right angle bracket for 30 mm sensors, 1/pk

