

Jumper Settings		
Jumper J1		
Pin 1 & 2 (DirectLOGIC)		Jumpers +24VDC to Pins 1, 7, 13, & 19
Pin 2 & 3 (CLICK)		Jumpers GND to Pins 1, 7, 13, & 19
Jumper J2		
Pin 1 & 2 (CLICK)		Jumpers +24VDC to Pins 2, 8, 14, & 20
Pin 2 & 3 (DirectLOGIC)		Jumpers GND to Pins 2, 8, 14, & 20

ZL-RRL16-24 Pinouts	
Connector Pin	Relay
3	Relay 1 (TB1)
4	Relay 2 (TB2)
5	Relay 3 (TB3)
6	Relay 4 (TB4)
9	Relay 9 (TB9)
10	Relay 10 (TB10)
11	Relay 11 (TB11)
12	Relay 12 (TB12)
15	Relay 5 (TB5)
16	Relay 6 (TB6)
17	Relay 7 (TB7)
18	Relay 8 (TB8)
21	Relay 13 (TB13)
22	Relay 14 (TB14)
23	Relay 15 (TB15)
24	Relay 16 (TB16)

WARNING: We recommend installing up to a 0.5 Amp fast-blow fuse such as AGC-5 or similar in series with the power supply as an extra safety measure.

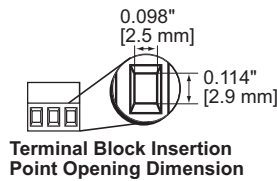
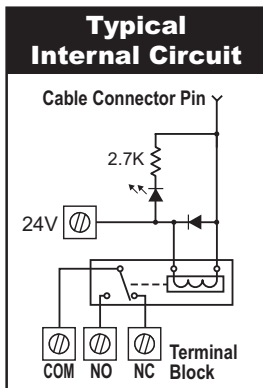
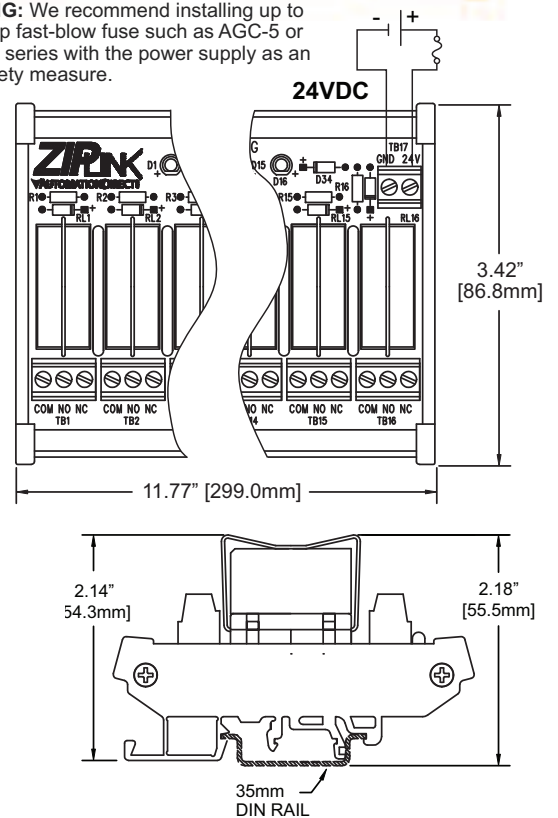

General Module Specifications		Relay Contact Specifications	
Description	16 Output Relay module with LEDs, 24 VDC coil	Current Rating	30VDC @ 10A General Use 250VAC @ 8A General Use
Mechanical Life	10,000,000 Operations at no load condition	Contact Type	1 Form C (SPDT)
Electrical Life	100,000 Operations at rated resistive load	Contact Voltage*	250VAC/30VDC
Operating Frequency	20 cycles per minute electrical 300 cycles per minute mechanical	Maximum Power Inductive	2000VA General Use
Isolation Coil to Contact	2500VAC for 1 minute	Maximum Power Resistive	AC 2000VA, DC 300W
Isolation NC Contact to NO Contact	1000VAC for 1 minute	Maximum Switching Voltage	250VAC, 110VDC
Isolation Between Relays	1000VAC for 1 minute	Minimum Load	10mA @ 5VDC
Red LED Indicator State Relay	ON = relay energized, OFF = relay de-energized	Contact Resistance	100mΩ Max @ 1A, 6VDC
Surrounding Temperature Range	32 to 140°F (0 to 60°C)	Contact Material	AgNi (Silver Nickel Alloy)
Humidity Range	45 to 85% RH	Coil Specifications	
Vibration Resistance	10 to 55 Hz dual amplitude width 1.5mm	Input Voltage Rating	24VDC (-20 / +30%)
Shock Resistances	1000m/s ² endurance, 100m/s ² operation	Maximum Continuous Coil Voltage	31.2VDC
Terminal Block Contacts	Copper alloy, tin-lead plated	Rated Current Per Coil	16.7mA (±10%) @ 24 VDC
Wire Range*	12-24AWG Solid or Stranded Conductor	Coil Resistance	1440Ω (±10%)
Wire Strip Length	0.24-0.27" (6-7mm)	Power Consumption Per Coil	0.4W
Screw Torque	4.4 in-lbs (0.5 Nm)	Total Coil Supply Current Max.	293mA (Total 16 relays)
Connector Type	Molex Micro-Fit 3.0, 24 pin connector, example receptacle 43020-2400, Pins 43031 Series, Male	Pick Up Current Max. Per Coil	15mA
Dimensions (LxWxH)	11.77" x 3.42" x 2.14" (299mm x 86.8mm x 54.3mm)	Drop-Out Voltage Min.	1.2VDC
Replacement Relays	ZL-RELAY-24X4, Qty. 4/pkg	Pick-Up Voltage Max.	19.2VDC
Approvals	File # E157382 UL, cUL 508, CE, EN 61131-2:2007	Off to On/On to Off Response Time	12mS/8mS
Cable/Wire Clearance	0.5" (12.7mm)		

*Use conductors rated 60°/75°C for relay outputs.

Remove or Install Relay

1 Rotate retaining clip away from relay.

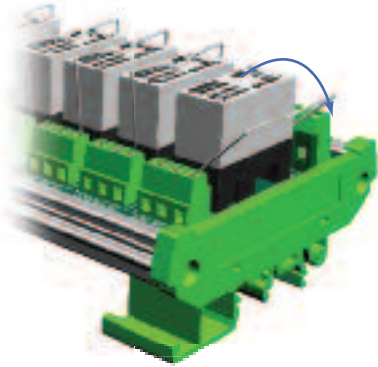

2 Remove relay from module.

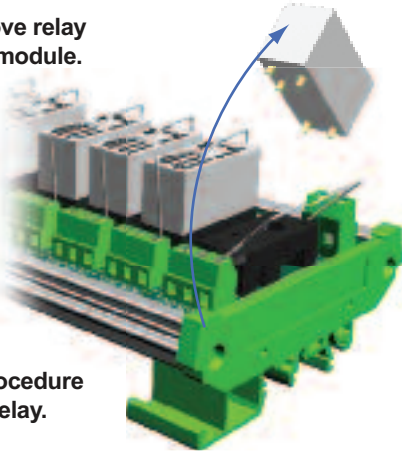

Reverse procedure to replace relay.

DIN Rail Installation and Removal

To install ZIPLink module, insert upper tab into DIN rail.

Note: For cable/wire clearance requirements see specifications.

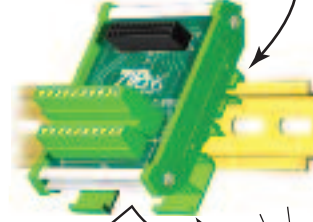

Rotate until firmly seated

Click

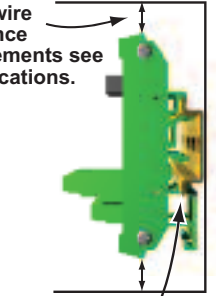

and locked on DIN rail.

To remove ZIPLink module, insert screwdriver between Tab 1 and module.



Pry up to release clip from DIN rail.

Tab 1

Tab 2

Repeat for Tab 2.

WARNING: To minimize the risk of potential safety problems, you should follow all applicable local and national codes that regulate the installation and operation of your equipment. These codes vary from area to area and it is your responsibility to determine which codes should be followed, and to verify that the equipment, installation, and operation are in compliance with the latest revision of these codes.

Equipment damage or serious injury to personnel can result from the failure to follow all applicable codes and standards. We do not guarantee the products described in this publication are suitable for your particular application, nor do we assume any responsibility for your product design, installation, or operation.

If you have any questions concerning the installation or operation of this equipment, or if you need additional information, please call Technical Support at 01737 824600.

This publication is based on information that was available at the time it was printed. At AutomationDirect.com® we constantly strive to improve our products and services, so we reserve the right to make changes to the products and/or publications at any time without notice and without any obligation. This publication may also discuss features that may not be available in certain revisions of the product.

ZIPLink Cable Removal

2 Pull connector from socket.

1 Push tab on raised tip and hold.

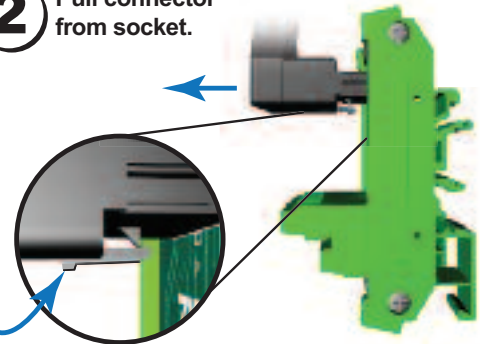

Heat Dissipation Mounting Requirements

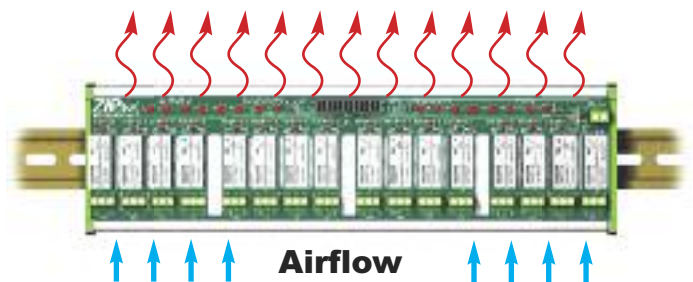

IMPORTANT! Mount Module horizontally to provide proper ventilation.